

OFF-THE-SHELF

# 2-METER MOLDED CABLES

MICRO-CON-X<sup>®</sup> & MINI-CON-X<sup>®</sup>  
INSTA-CLICK<sup>®</sup> CONNECTORS



**Switchcraft**<sup>®</sup>  
**CONXALL**<sup>®</sup>

HARSH ENVIRONMENT CONNECTIVITY SOLUTIONS

High quality, factory overmolded connectors

Blunt cut on opposite end for maximum flexibility

Color coded, tissue paper separated conductor wires for easy termination

Sealed to IP68 with UL f1 Rated UV Resistance

Standard 2-Meter (79") Lengths

## FEATURES

- High quality molded cables now available as a standard, off-the-shelf item
- Sealed to IP68 with UL f1 rated UV resistance
- Single ended cable with blunt cut
- Straight or right angle connector options
- Made in the USA
- Call factory for custom lengths and other configurable options
- See drawings on [Switchcraft.com](http://Switchcraft.com) for detailed specifications

## CABLE SPECIFICATIONS

- Rated for 300 V
- 16 AWG, 20 AWG, or 22 AWG Wire
- -30° C TO +105° C temperature rating
- Jacket Material: 30 mils PVC, black
- Conductor Insulation: 15 mils PVC
- UV & water resistant
- Color coded and tissue paper separated conductor wires
- UL Recognized, CSA Certified, and RoHS Compliant

## CONNECTOR DIMENSIONS (Ref Only)

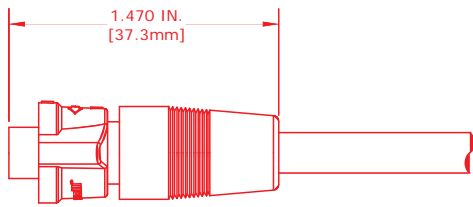

CA16X80XXP0779

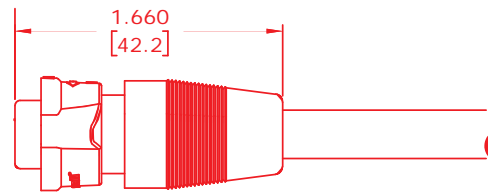

CA6X80XXP07900

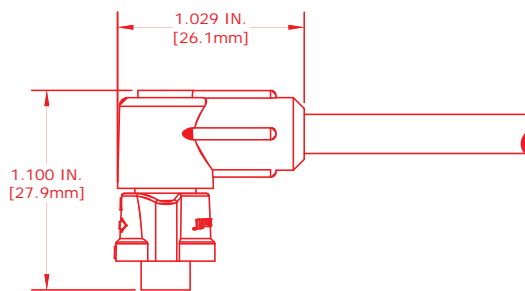

CARA16X80XXP07990

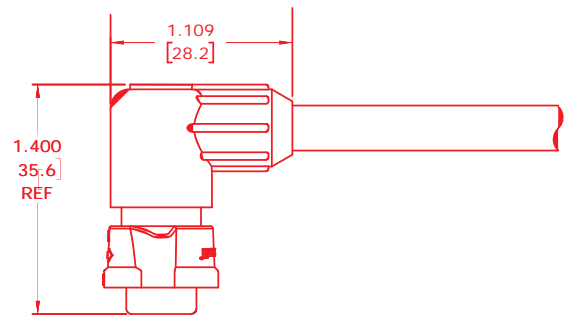

CARA6X80XXP07990

## CONTACT LAYOUTS (Connector Face Side)

### MICRO-CON-X® INSTA-CLICK®

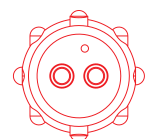

2 POSITION  
#20 PIN & SOCKET  
CONTACT

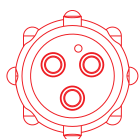

3 POSITION  
#20 PIN & SOCKET  
CONTACT

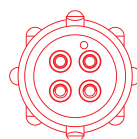

4 POSITION  
#22 PIN & SOCKET  
CONTACT

### MINI-CON-X® INSTA-CLICK®



2 #20  
(Pin and Socket)

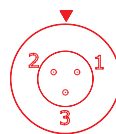

3 #20  
(Pin and Socket)

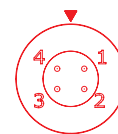

4 #20  
(Pin and Socket)



5 #20  
(Pin and Socket)



6 #20  
(Pin and Socket)

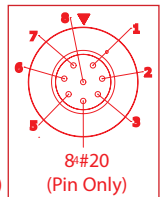

8 #20  
(Pin Only)

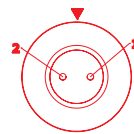

2 #16  
(Pin and Socket)

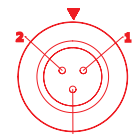

3 #16  
(Pin and Socket)

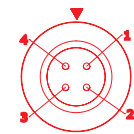

4 #16  
(Pin and Socket)

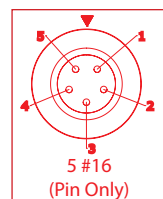

5 #16  
(Pin Only)

## DETAILS AND AVAILABLE PART NUMBERS



| Configuration              | Micro-Con-X       |                   | Mini-Con-X       |                  |
|----------------------------|-------------------|-------------------|------------------|------------------|
|                            | #20 Contacts      | #22 Contacts      | #16 Contacts     | #20 Contacts     |
| Straight, 2-pos, Male      | CA162802PP07990   | N/A               | CA63802PP07990   | CA62802PP07990   |
| Straight, 2-pos, Female    | CA162802SP07990   | N/A               | CA63802SP07990   | CA62802SP07990   |
| Straight, 3-pos, Male      | CA162803PP07990   | N/A               | CA63803PP07990   | CA62803PP07990   |
| Straight, 3-pos, Female    | CA162803SP07990   | N/A               | CA63803SP07990   | CA62803SP07990   |
| Straight, 4-pos, Male      | N/A               | CA168804PP07990   | CA63804PP07990   | CA62804PP07990   |
| Straight, 4-pos, Female    | N/A               | CA168804SP07990   | CA63804SP07990   | CA62804SP07990   |
| Straight, 5-pos, Male      | N/A               | N/A               | N/A              | CA62805PP07990   |
| Straight, 5-pos, Female    | N/A               | N/A               | CA63805SP07990   | CA62805SP07990   |
| Straight, 6-pos, Male      | N/A               | N/A               | N/A              | CA62806PP07990   |
| Straight, 6-pos, Female    | N/A               | N/A               | N/A              | CA62806SP07990   |
| Straight, 7-pos, Male      | N/A               | N/A               | N/A              | N/A              |
| Straight, 7-pos, Female    | N/A               | N/A               | N/A              | CA62807SP07990   |
| Straight, 8-pos, Male      | N/A               | N/A               | N/A              | N/A              |
| Straight, 8-pos, Female    | N/A               | N/A               | N/A              | CA62808SP07990   |
| Right Angle, 2-pos, Male   | CARA162802PP07990 | N/A               | CARA63802PP07990 | CARA62802PP07990 |
| Right Angle, 2-pos, Female | CARA162802SP07990 | N/A               | CARA63802SP07990 | CARA62802SP07990 |
| Right Angle, 3-pos, Male   | CARA162803PP07990 | N/A               | CARA63803PP07990 | CARA62803PP07990 |
| Right Angle, 3-pos, Female | CARA162803SP07990 | N/A               | CARA63803SP07990 | CARA62803SP07990 |
| Right Angle, 4-pos, Male   | N/A               | CARA168804PP07990 | CARA63804PP07990 | CARA62804PP07990 |
| Right Angle, 4-pos, Female | N/A               | CARA168804SP07990 | CARA63804SP07990 | CARA62804SP07990 |
| Right Angle, 5-pos, Male   | N/A               | N/A               | N/A              | CARA62805PP07990 |
| Right Angle, 5-pos, Female | N/A               | N/A               | CARA63805SP07990 | CARA62805SP07990 |
| Right Angle, 6-pos, Male   | N/A               | N/A               | N/A              | CARA62806PP07990 |
| Right Angle, 6-pos, Female | N/A               | N/A               | N/A              | CARA62806SP07990 |
| Right Angle, 7-pos, Male   | N/A               | N/A               | N/A              | N/A              |
| Right Angle, 7-pos, Female | N/A               | N/A               | N/A              | N/A              |
| Right Angle, 8-pos, Male   | N/A               | N/A               | N/A              | CARA62808PP07990 |